



J. STEPHEN Lab., Ltd.

374-2, Gajang-dong, Osan-si, Gyeonggi-do, 447-210, Korea  
TEL : +82-31-459-8200 FAX : +82-31-459-8880  
www.miniprinter.com



**MODEL : LK-P30**

MOBILE PRINTER



**Disposal of Old Electrical&Electronic Equipment(Applicable in the European Union and other European countries with separate collection systems)**

This symbol on the product or on its packaging indicates that this product shall not be treated as household waste.

Instead it shall be handed over to the applicable collection point for the recycling of electrical and electronics equipment. For more detailed information about recycling of this product, please contact your local city office, your household waste disposal service or the shop where you purchased the product.

# Table of Contents

1. Safety Caution	4
2. Unpacking	6
3. Product overview	7
4. Usage and Installation	8
4-1. Control panel usage	9
4-2. Battery Installation	10
4-3. Battery removal	11
4-4. Battery charging	12
4-5. Battery charger usage (Optional)	13
4-6. Usage of Cigar Jack for charging (Optional)	14
4-7. Belt clip usage	15
4-8. Roll paper installation	16
4-9. Leather case usage (Optional)	17
4-10. Self test	18
4-11. MSR usage (Optional)	19
4-12. IC CARD usage (Optional)	20
5. Peripherals connection	21
5-1. Bluetooth connection (Optional)	21
5-2. Wi-Fi(802.11b/g) connection (Optional)	21
5-3. Interface cable connection	22
6. Roll media specification	23
7. Label specification	24
8. Black Mark	25

9. Printer cleaning	26
10. Printer specification	27
10-1. Specification	27
11. CPCL Command Compatibility	29
12. Certification	32
13. Setting up the software	34

# 1. Safety Caution

For higher reliability and safety, consider the following precautionary measures. Read and follow the instructions carefully before running of the product.

## Indication



Prohibition



Must follow



Do not disassemble



Unplug the power from the outlet



Grounding to prevent electric shock



Do not handle the product with wet hands



## WARNING

Failure to follow these instructions could result in fire, electric shock, or other injuries, or property damage

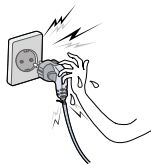

Do not pull or touch the power plug with wet hands.

(Potential risk of electric shock or fire)

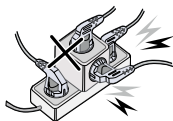

Do not overload the power plug into one outlet.

(Potential risk of electric shock or fire)



Do not bend the wire and do not allow the wire to be pressed by heavy object.

(Potential risk of electric shock or fire)

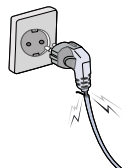

If a power plug is broken or a plug is cut or worn, do not use it.

(Potential risk of electric shock or fire)



## WARNING

Failure to follow these instructions could result in fire, electric shock, or other injuries, or property damage

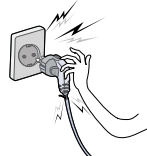

Do not pull out the power plug to turn off the product.

(Turn off the power at installation, transportation, wiring and inspection.)



Do not disassemble, repair or modify the product.

(Potential risk unit malfunction, electric shock or fire. When the product needs to be repaired, please contact in place where you ordered.inspection.)



## CAUTION

Failure to follow these instructions could result in fire, electric shock, or other injuries, or property damage



Do not install the product in uneven or inclined surface.

(You may get hurt and it can be broken when it falls)



Keep product away from the water and other material.

(Potential risk of discoloration or electric shock)

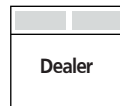

If the product that needs to be repaired, please contact in place where you ordered.

(Potential risk of fire or unit malfunction)

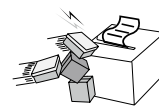

Please do not give excessive shock.

(Potential risk of fire or unit malfunction)

## 2. Unpacking

### Standard

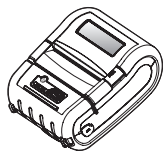

Printer

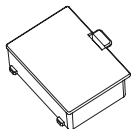

Battery

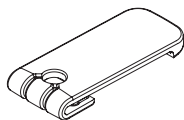

Belt Buckle

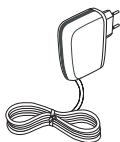

Charger

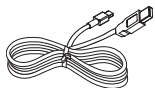

USB Cable Shielded

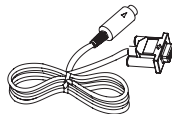

Serial Cable

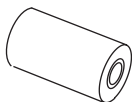

Roll paper



CD



Quick Manual

### Optional

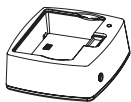

Battery Holder (Cradle)



Cigar Jack Charger

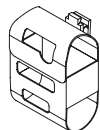

Leather case

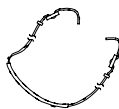

Shoulder strip

## 3. Product overview

### Front

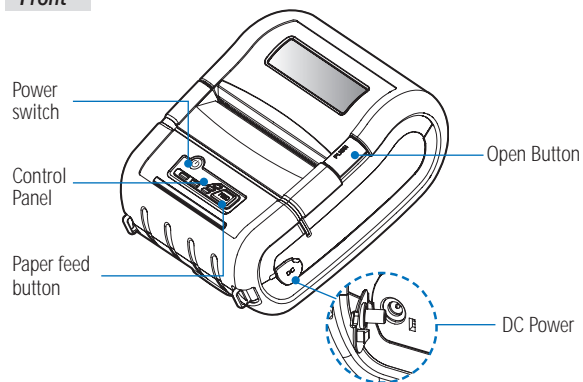



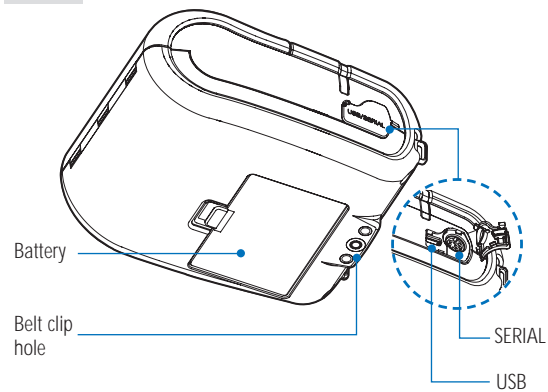

### Rear

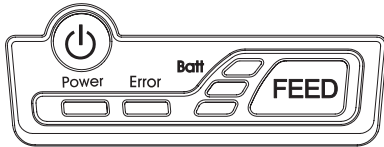

## 4. Usage and Installation

### 4-1 Control panel usage



Button	Name	function
	Power button	This button is used to turn the printer on and off. When the printer is off, press this button for approximately 3 seconds and it will turn on the power. When you press this button in a state that the printer is on, the printer will turn off.
	Paper Feed Button	Paper output can be done manually by pressing this button. Additionally, self-testing and Hexadecimal Dumping can be processed. 1. Refer to "4-10" for self test information. 2. Refer to the service manual regarding Hexadecimal Dumping.
	Battery Status Lamp	1. If the Batt, LED are Lit, the battery is fully charged. 2. If you can hear beeping sound and LED light is turned off, it means that the battery is at the lowest level. 3. If the battery is not charged at all, the printer turns off automatically.
	Error Lamp	If the red light is turned on, it means there is no paper roll or the paper cover is open.

### 4-2 Battery Installation

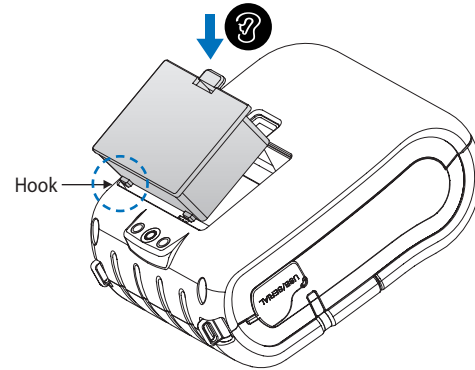

1. Align battery hook as shown in the picture
2. Push the battery into the printer until it locks in place.

#### **NOTE**

As the battery is not charged at the time of your purchase, charge the battery prior to using the printer (Battery charger or Cradle can be used to charge)

#### **CAUTION**

Risk of explosion if battery is replaced by an incorrect type. Dispose of used batteries according to the instructions

### 4-3 Battery removal

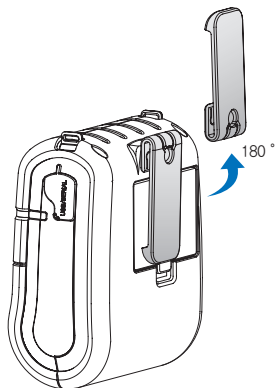

Put up the Belt clip hole turning 180 degree.

1  
2

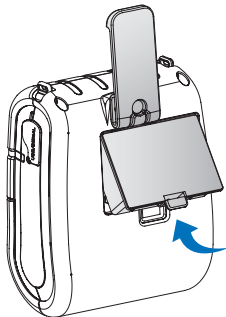

After putting up the belt clip, remove the battery holding it up as shown above.

### 4-4 Battery charging

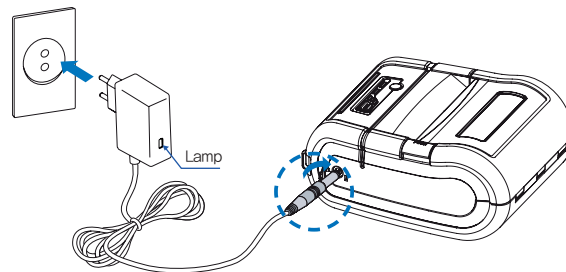

1. Be sure that the printer is turned off
2. After open the DC JACK cover, insert DC JACK into the printer.
3. Plug the power code to electrical outlet.

#### 4-4-1 The status of lamp in charging

Status	charging	charging complete
Charging Lamp	Red	Green

#### NOTE

1. Unless the exclusive charger is used provided by the manufacturer, the printer can be damaged, and the manufacturer is not liable for the consequential damage.
2. Before removing the battery, make sure that power is turned off.
3. Printer does not work in the status of being connected with charger only.
4. The battery should be installed to operate printer.
5. While charging, do not turn on the power.
6. Do not operate the print while charging the battery.
7. Do not connect the charger while the printer is operated.

## 4-5 Battery charger usage

Optional

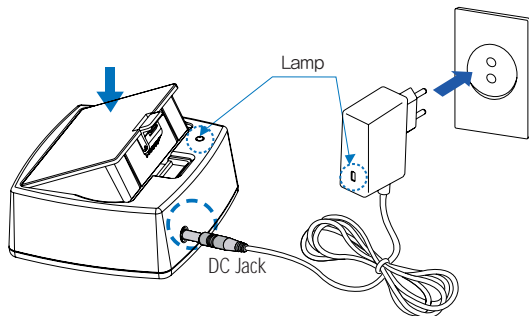

1. Insert the battery into the battery holder as shown above
2. Connect the DC JACK to the power electrical outlet.
3. Plug the power cord into the electrical outlet.
4. Once the charging is completed, remove the battery from the holder.

### 4-5-1 The status of lamp in charging

Status	charging	charging complete
Charging Lamp	Red	Green

#### ✔ NOTE

In the case the battery is not fixed properly in the holder, the red lamp will be blinking, Then, extract and reinsert the battery.

## 4-6 Usage of Cigar Jack Charger for charging

Optional

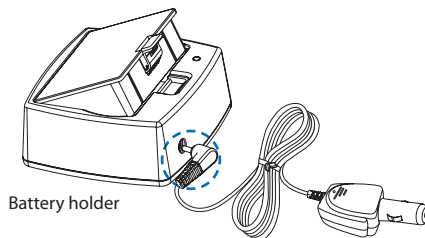
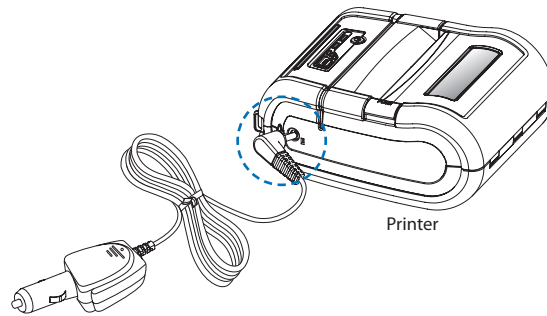

Connect the car cigar JACK charger into the printer or battery holder.

Input	12 ~ 24V
Output	8.4V 0.8 ~ 1.2A

#### ✔ NOTE

Use the Cigar Jack offered by the manufacturer.



#### 4-7 Belt Clip usage

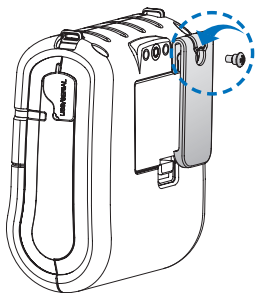

Insert the belt clip screw into the hole of Belt clip

1  
2

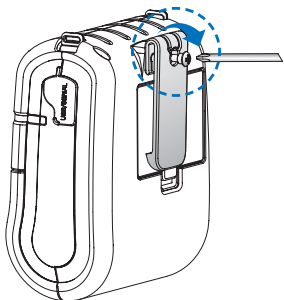

As shown in the picture, tighten the screw with a screw driver.

#### 4-8 Roll Paper installation

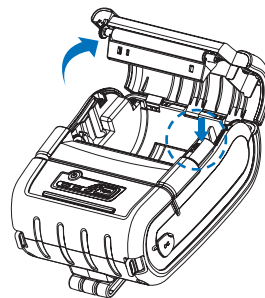

Press the PUSH button to open the paper cover

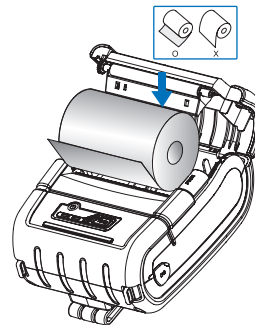

Insert the paper in the right direction

1  
2  
3  
4

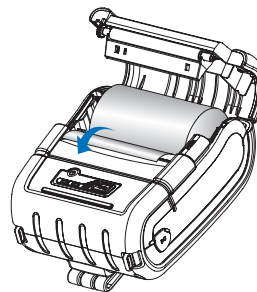

Pull a short length of paper out of the printer and close the cover.



Tear off the additional paper using tear bar.

## 4-9 Leather case usage

Optional

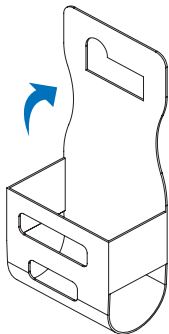

Open the leather case

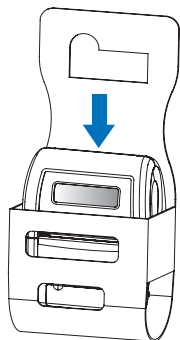

Place the printer into the leather case

1 2  
3 4

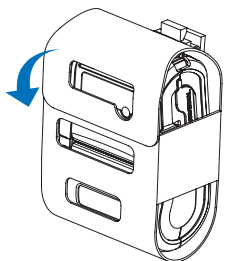

Close the Velcro and stick the cover.

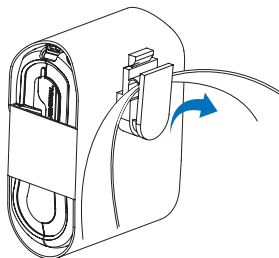

Fasten to the belt by using the clip at the rear of the leather case

## 4-10 Self Test

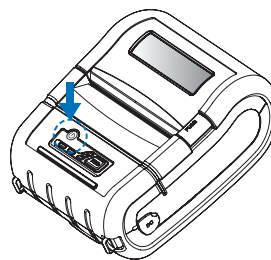

Turn off the power pressing the power button for approximately 3 seconds.

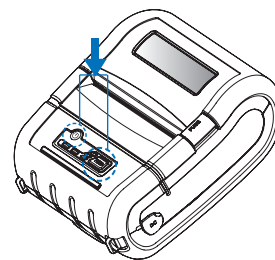

While you are pressing the FEED button, press the power button

1 2  
3

### NOTE

1. To print ASCII pattern additionally, press the Feed button once more
2. After printing ASCII pattern, the self test will be finished automatically.
3. If the Feed button is not pressed to print ASCII pattern, self test will be finished automatically after 3 seconds.

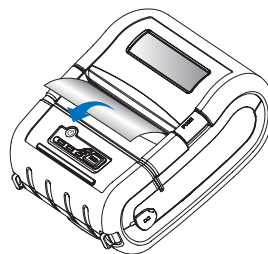

The printout is produced.

### The sample of self test printout

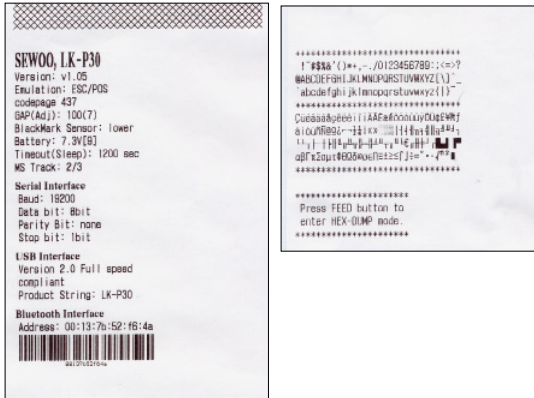

When the printer is installed initially or when you face a problem, you can run the self test and check the information about

-Control Circuit, Mechanism, Print Quality, ROM Version

After checking with self-test and no issues are found, you can examine other devices and software. This function is working independent of devices and software.

- Motor protection from being overheated

The motor should be stopped and cooled about more than 30 seconds after continuous printing 1.5 meter

## 4-11 MSR usage

### Optional

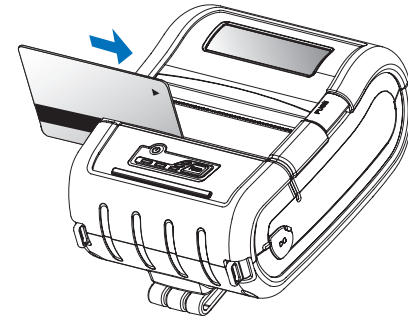

Insert and swipe the card in the direction of the arrow as shown in the picture.

#### 4-12 IC CARD usage

Optional

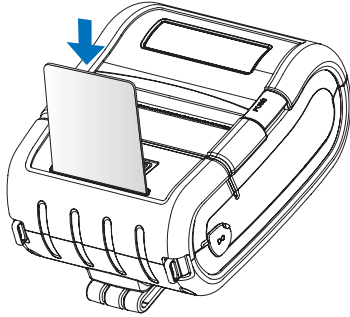

Insert the card in the direction of the arrow as shown in the picture.

## 5. Peripherals connection

This product can communicate with other devices via Bluetooth or Wi-Fi(802.11b/g) communication and cable.

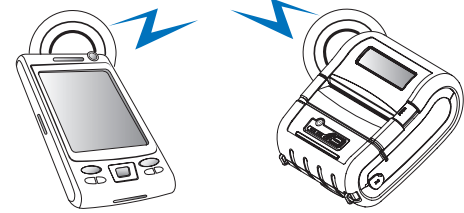

### 5-1 Bluetooth Connection Optional

1. The Printer can be connected to devices equipped with Bluetooth communication capacity (PDAs, PCs, etc.)
2. Use the Bluetooth connection function supported by the device to connect to the printer.

**NOTE**

Refer to the Bluetooth Manual for more details on connection.

### 5-2 Wi-Fi(802.11b/g) Connection Optional

1. The Printer can be connected to devices equipped with Wi-Fi(802.11b/g) communication capacity (PDAs, PCs, etc.)
2. Use the Wi-Fi(802.11b/g) connection function supported by the device to connect to the printer.

**NOTE**

Refer to the Wi-Fi(802.11b/g) Manual for more details on connection.

### 5-3 Interface Cable Connection

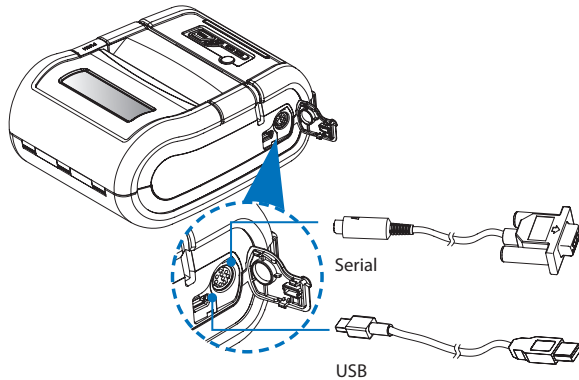

1. Connect USB or Serial cable into the cable connector on the printer.

**NOTE**

Use the cable offered by the manufacturer (USB, Serial)

2. Connect the interface cable into the USB or Serial port of the device (PDA, PC, etc.)

## 6. Roll media specification

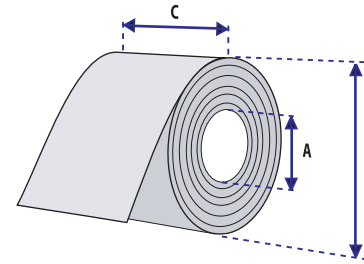

Core	
Diameter(A)	12.5mm +/-0.5mm
Roll	
Max.diameter(B)	Max. $\phi$ 56mm
Max.media width(C)	79.5 $\pm$ 0.5mm
Min.media width(C)	25.4 $\pm$ 0.5mm
Max.media thickness	0.16mm
Min.mdeia thickness	0.06mm



Protect the media against sand, grit, and other hard particles during printing and storage. Keep the cover closed. Even very small foreign particles may cause severe harm to the delicate printhead.

## 7. Label specification

<- a --> Media width (inch, liner)	
Maximum	79.5±0.5mm
Minimum	24.5±0.5mm
<- b --> Label length	
Minimum	15 mm
<- c --> Label gap height	
Maximum	7 mm
Minimum	3 mm
Liner	
Opacity	50~75%

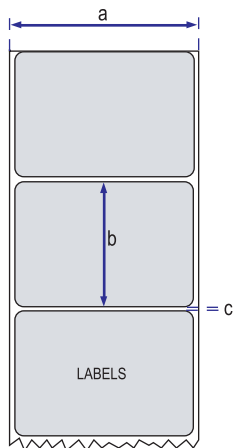

## 8. Black Mark

Mark	Item	Dimensions
A	Right edge of black mark	26mm or more
B	Left edge of black mark	0.5mm or less
C	Black mark height	3mm
D	Cut position in black mark	1.5mm
E	Top margin	13mm
F	Black mark pitch	30mm to 300mm
G	Bottom margin	13mm

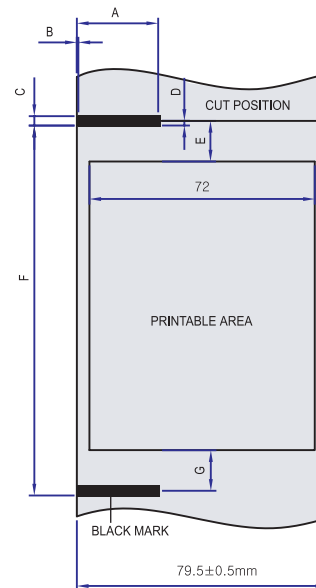

## 9. Printer cleaning

If the interior of the printer is dusty, printing quality can be lowered. In such a case, follow the instructions below to clean up the printer.

### ✔ NOTE

1. Make sure to turn the printer power off prior to cleaning
2. Regarding print head cleaning, as the print head gets very hot during printing, turn off the printer power and wait approximately 10 minutes before commencement.
3. When cleaning the print head, take care not to touch the heated portion of the print head. The print head is subject to be damaged by static electricity.
4. Take care not to allow the print head to become scratched and/or damaged in any way.

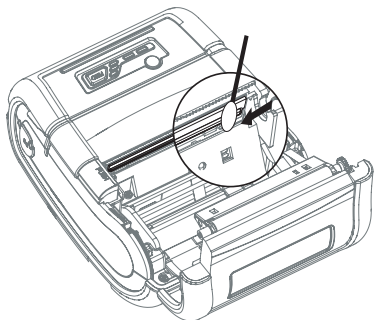

1. Use an applicator swab moistened with an alcohol solution to clean the print head and remove any dusts.
2. Once the cleaning is completed, insert paper roll into the printer a few minutes later and close the printer cover.

### ✔ Preventing Overheating

To prevent the motor from overheating, continuous driving of the printer should be 1.5 m or less in print length. Set the pause time for 30 seconds or more after driving the printer.

## 10. Printer Specification

### 10-1 Specification

Printing Method	Direct Thermal	
Printing Speed	100mm/sec	
Resolution	203 DPI X 203 DPI	
Character	Font A (12X24), Font B (9X17)	
Character per line	Font A : 48pt , Font B : 64pt	
Character set	ALPHA NUMERIC Character, Extension Character	
Barcode	EAN-8, EAN-13, Code39, ITF, UPC-A, UPC-E, Codabar, Code93, Code128, PDF417(2D), MAXIcode (2D)	
Emulation	ESC/POS, CPCL, Commanl Compatible	
Driver	Window CE 4.2&5.0, Window Mobile 5.0	
Sensor	Paper End Sensor , Gap Sensor , Cover Open Sensor , Black Mark Sensor	
Paper	Paper type	Thermal Paper
	Width	25.4mm~79.5mm
	Thickness	0.06mm ~ 0.16mm
	External Diameter	Max. $\phi$ 56mm
	Internal Diameter	12.5mm +/-0.5mm
Reliability	TPH	50km
	Battery	Continuous Printing 36min Standby: 19hour Printing length: 186m
Communications	Standard	Serial(RS-232C), USB
	Optional	Bluetooth Class2 or Wi-Fi(802.11b/g)
MSR (Optional)	Card Standard	ISO7811/2, JIS
	Track	1Track, 2Track, 3Track(or JIS-II)
	Magnet Head Life	300,000 Passes(minimum)

## 11. CPCL Command Compatibility

CHANGE of printing resolution	ESC/POS	0~15 (μ 8)
	CPCL	-99 ~ 200 (μ 0)
IC CARD (Optional)		EMV™ level one certified smart card reader
Battery Charger	Input	AC100~240V, 50/60Hz
	Output	8.4V , 800~1400mA
Battery	Battery type	Li-ion
	Output	7.4V, 2200mAh
	Charging time	220min
Size	W x D x H(mm)	120 X 152 X 70
	W x D x H"	4.7 X 5.9 X 2.7
Weight		0.6kg
Environmental sealing		IP42, IP54 certified
Temperature	Operation	-10 ~ 50°C
	Storage	-20 ~ 60°C
Humidity	Operation	35 ~ 95%
	Storage	10 ~ 80%

### NOTE

Compatible	Compatible with only commanders provided by the manufacturer.	Partially Compatible	Not Compatible
○	●	△	x

Printer Commands	Compatibility
PRINT	○
FORM	○
JOURNAL	○
UNITS	○
Comments	○
TEXT	Compatibility
TEXT	○
FONT-GROUP(FG)	○
TEXT CONCATENATION	○
MULTILINE(ML)	○
COUNT	○
SETMAG	○
SCALABLE TEXT	X
Linear Bar Codes	Compatibility
BARCODE	○
BARCODE-TEXT	○
Two-Dimensional Bar Codes	Compatibility
PDF417 (PORTABLE DATA FILE)	○
MAXICODE	○
QRCODE	●
DATAMATRIX	●
GS1(RSS)	●



Graphics	Compatibility
BOX	○
LINE	○
INVERSE-LINE	○
PATTERN	○
GRAPHICS	○
PCX	○
Advanced Commands	Compatibility
CONTRAST	○
tone	○
JUSTIFICATION	○
PAGE-WIDTH	○
PACE	○
NO-PACE	○
WAIT	○
REWIND	X
TENSION	X
SPEED	○
SETSP	○
ON-OUT-OF-PAPER	X
ON-FEED	○
PREFEED	○
POSTFEED	○
PRESENT-AT	X
COUNTRY/CODE PAGE	○
FORMAT FILES	○
BEEP	○
CUT	X
PATIAL-CUT	X
MCR	●

Line Print Mode	Compatibility
SETLP	○
SETLF	○
Moving With X and Y Coordinates	○
LMARGIN	○
SETBOLD	○
SETSP	○
Special ASCII Characters	○
SETFF	○
SET-TOF	○
SETLP-TIMEOUT	○

## 12. Certification

### FCC Information

This device complies with part 15 of the FCC Results. Operation is subject to the following two conditions:

- (1) This Device may not cause harmful interface, and
- (2) This device must accept any interference received, including interference that may cause undesired operation.

This Class [B] digital apparatus complies with Canadian ICES-003.  
Cet appareil numerique de la classe [B] est conforme a la norme NMB-003 du Canada.

Operation is subject to the following two conditions: (1) this device may not cause harmful interference, and (2) this device must accept any interference received, including interference that may cause undesired operation of the device.

### **✔ NOTE**

This equipment has been tested and found to comply with the limits for CLASS B digital device, pursuant to Part 15 of FCC Rules. These limits are designed to provide reasonable protection against harmful interference when the equipment is operated in a commercial environment. This equipment generates, uses and can radiate radio frequency energy and, if not installed and used in accordance with the instructions, may cause harmful interference to radio communications. However, there is no guarantee that interference will not occur in a particular installation. If this equipment does cause harmful interference to radio or television reception, which can be determined by turning the equipment off and on, the user is encouraged to try correct the interference by one or more of the following measures:

- 1.1. Reorient or relocate the receiving antenna.
- 1.2. Increase the separation between the equipment and receiver.
- 1.3. Connect the equipment into an outlet on a circuit different from that to which receiver is connected.
- 1.4. Consult the dealer or experienced radio/TV technician for help.

### **⚠ WARNING**

Changes or modifications not expressly approved by the manufacturer could void the user's authority to operate the equipment.

### **⚠ CAUTION**

Antenna shall be mounted in such a manner to minimize the potential for human contact during normal operation. The antenna should not be contacted during operation to avoid the possibility of exceeding the FCC radio frequency exposure limit.

The device meets the FCC requirements for radio frequency (RF) radiation exposure in the standard body worn configuration with no minimum configuration. In this configuration, which applies whether the belt clip or shoulder strap is used, the face of the printer from which paper is transported is facing away from the user's body. The standard configuration must always be used when the printer is body worn.

## 13. Setting up the software

*Please refer to the programming manual included in CD.*

PATENT

